

LCM Systems Ltd

Unit 15, Newport Business Park
Barry Way, Newport, Isle of Wight
PO30 5GY United Kingdom
Tel: +44 (0)1983 249264
sales@lcmsystems.com
www.lcmsystems.com

INNOVATIVE

Large digit load cell display

LD-SERIAL 4 digit version

Installation & Operating Manual

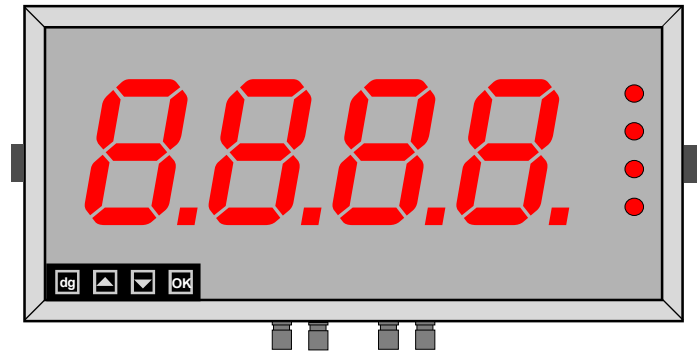

- ✓ Easy setup
- ✓ Addressable
- ✓ Flexible string extraction
- ✓ Can totalise numeric strings
- ✓ Optional Output 4-20mA / 0-10V isolated
- ✓ Optional Alarm output = 2 or 4 relays
- ✓ Optional Comms Output = RS232 or RS485
- ✓ 110-230V AC or 11-30V DC power

Caution: There is a risk of electrical shock if this instrument is not properly installed



Caution: Risk of danger: Read the whole manual before you install this meter



Warranty

We warrant our products against defects in materials or workmanship for a period of three (3) years from the date of purchase.

In the event of a defect during the warranty period, the unit should be returned, freight (and all duties and taxes) prepaid by the Buyer to the authorised distributor from where the unit was purchased.

The Distributor, at its option, will repair or replace the defective unit. The unit will be returned to the Buyer with freight charges prepaid by the distributor.

LIMITATION OF WARRANTY

The foregoing warranty shall not apply to defects resulting from:

1. Improper or inadequate maintenance by the buyer.
2. Unauthorised modification or misuse.
3. Operation outside the environmental specification of the product.
4. Mishandling or abuse.

The warranty set forth above is exclusive and no other warranty, whether written or oral is expressed or implied. We specifically disclaim the implied warranties of merchantability and fitness for a particular purpose.

EXCLUSIVE REMEDIES

The remedies provided herein are the buyer's sole and exclusive remedies.

In no event shall we be liable for direct, indirect, incidental or consequential damages (including loss of profits) whether based on contract, tort or any other legal theory.

Contents

Warranty	2
Warnings	4
Introduction	5
General Description	6
Suspension Mounting	7
Wall Mounting	8
Panel Mounting	9
Connections	10-11
Installation hints for best performance	12-13
Declaration of Conformity	14
Language Selection	15
Display Brightness	16
Display Modes	17
Serial Data settings	18-19
Logic Input functions	20
Logic Input connections & Front Buttons	21
Factory defaults	22
Calibration Audit number	22
Scale Factor adjustment	23
Offset Adjustment	24
Menu Timeout adjustment	25
Reverse / Mirror display setting	26
Bootup Routine choices	27
Multi Memory MEM option	28
Error Codes and fault finding	29
Output Options - installing	30
WEEE	31
Equipment Specifications	32
Record of Revisions	33
ASCII Hex codes and displayed characters	34
Signal Levels	35
Special data commands	35
Separate manuals for options	
Alarm option settings	See Alarm manual *
Analogue output option settings	See Analogue manual *
Serial output option settings	See Serial manual *
Real Time Clock setting	See Serial manual *

* Need a manual urgently?

You can download manuals from our website.

Warnings

Please carefully read this manual and all warnings. Install the display ONLY when you are sure that you've covered all aspects.



Where the product is intended for "UL" installations, removal or addition of option boards is not permitted.



Check that the model number and supply voltage suit your application before you install the display.



Connect the display according to current IEE regulations, IEC61010 & NFPA:70 National Electric Code in USA.



Power supplies to this equipment must have anti-surge (T) fuses rated at 1A for 230V supply, 2A for 110V, 5A for 48VAC supply or 10A for DC supplies in the range 11-30VDC.



Don't touch any circuitry after you have connected the display, because there may be lethal voltages on the circuit board.



Do not apply power to the display if its case is open.



Only adjust on-board switches or connections with the power turned off



Make sure all screw terminals are tight before you switch the meter on.



Only clean the display's case and window with a soft damp cloth. Only lightly dampen with water. Do not use any other solvents.

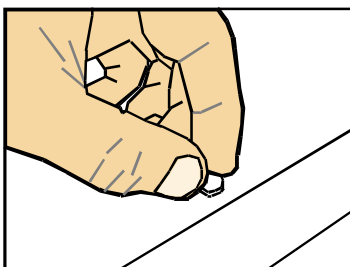

Rear case screws - please note

The rear panel is held in place with finger-screws, which only need to be gently tightened.

Do not use tools to tighten or loosen the screws, as this could cause damage to the internal threads.

Safety FirstDon't assume anything..... Always double check. If in doubt, ask someone who is QUALIFIED to assist you in the subject.

Introduction

Please contact us if you need help, if you have a complaint, or if you have suggestions to help us improve our products or services.

If you contact us about a product you already have, please tell us the full model number and serial number, so that we can give you accurate and fast help.

This product has a 3 year warranty. We will put right or replace any display which is faulty because of bad workmanship or materials. This warranty does not cover damage caused by misuse or accident.

If you return a unit for repair, please include a detailed description of the problem, and the name of a contact who we can refer to for any questions. Please mark for the attention of the QA Department.

IMPORTANT

If this equipment is important to your process, you may want to buy a spare to cover possible failure or accidental damage in the future.

This is because during factory shutdown periods, you may have to wait several weeks for an equivalent replacement, or we may have no stock at the time you urgently need it.

You may also need to pay extra carriage charges if you want a fast, guaranteed courier service. Warranty repairs or replacements are usually returned with a standard courier service.

We do not offer compensation for losses caused by failure of this instrument.

If you do not agree with these conditions, please return this item in unused condition, in its original packaging and we will refund the purchase price, excluding any carriage paid.

We thought you'd prefer to know about possible delays and extra charges now, rather than during a panic. A spare unit could help to avoid these issues.

We always try to improve our products and services, so these may change over time. You should keep this manual safely, because future manuals, for new designs, may not describe this product accurately.

We believe these instructions are accurate, and that we have competently designed and manufactured the product, but please let us know if you find any errors.

General Description

This series of displays accepts industrial sensors to allow various physical measurements to be made, such as weight, temperature, pressure, humidity etc. Different models are available for different sensor types.

The main function of this series is to give a clear numeric readout of the variable being monitored. Most models include an excitation power output, to power the sensor directly.

Various digit heights are available, to suit the maximum viewing distance required in each installation. For every 10 metres of viewing distance required, use 1" of digit height.

Various optional output modules are also available to give alarm relay outputs, analogue output or digital communications, or any combination of these options.

Displays are programmed using front panel pushbuttons. The front panel buttons can be disabled. In addition, you can connect 4 remote wired pushbuttons to the display, so that you can make adjustments while the display is mounted in an inaccessible location.

Displays have three power supply options : 100-240 VAC, 48 VAC or 11-30VDC

These displays must be installed fully assembled, and must be installed according to local electrical installation rules.

When properly installed, and provided they have been ordered with cable glands exiting the lower surface of the case, they provide ingress protection to IP65 / NEMA4X from all directions.

Safety



Caution: There is a risk of electrical shock if this display is not properly installed



Caution: Risk of danger: Read the whole manual before you install this display

Obey all safety warnings in this manual, and install the display according to local wiring and installation regulations. Failure to follow these guidelines may cause damage to the display, connected equipment, or may be harmful to personnel.

Any moving mechanical device controlled by this equipment must have suitable access guards to prevent injury to personnel if the display should fail.

Suspension Mounting dimensions

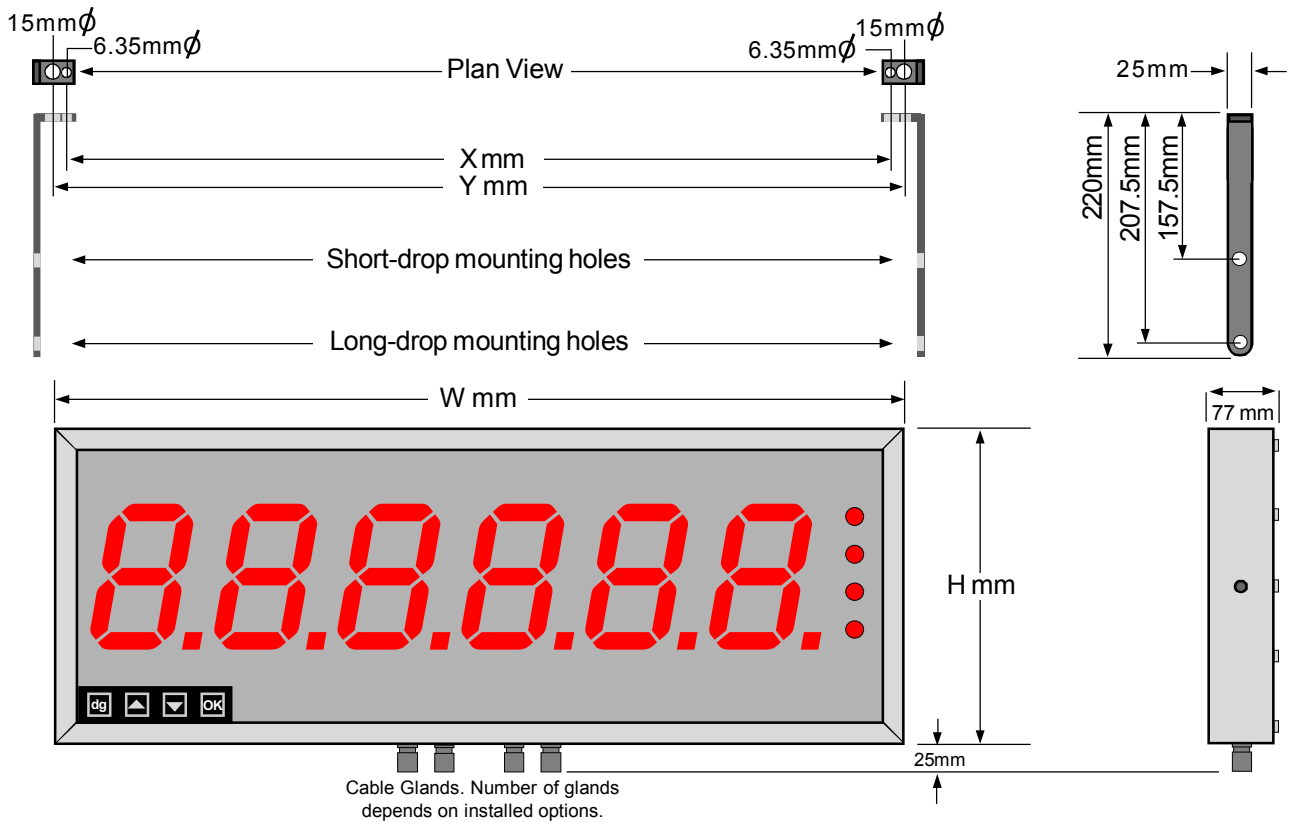

Detail showing bracket hardware fitting sequence

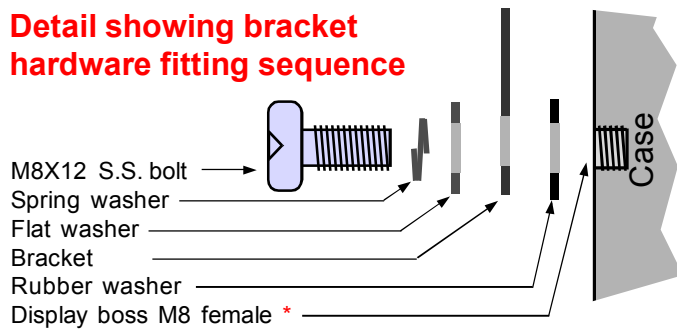

You can order these displays with the cable glands in the bottom surface (as shown) the rear, or top.

Rear glands allow you to mount the display on top of a cubicle, using the brackets shown.

* Do not use longer bolt threads than 12mm , or you will fracture the female boss and the case will no longer be sealed.

Display Format	X mm	H mm	W mm	Y mm
2" 4 digit clock	231	154.5	291	247
2" 4 digit numeric	219.5	154.5	279.5	249.5
2" 6 digit clock	340	154.5	400	370
2" 6 digit numeric	316	154.5	376	346
4" 4 digit clock	393	195.5	453	423
4" 4 digit numeric	374	195.5	434	404
4" 6 digit clock	593	195.5	653	623
4" 6 digit numeric	556	195.5	616	586
6" 4 digit	520	246	580	550
6" 6 digit	760	246	820	790
8" 4 digit	690	290	750	720
8" 6 digit	1012	290	1072	1042
12" 4 digit	990	408	1050	1020
12" 6 digit	1480	408	1540	1510
16" 4 digit	1308	515	1368	1338
16" 6 digit	1960	515	2020	1990

Wall Mounting dimensions

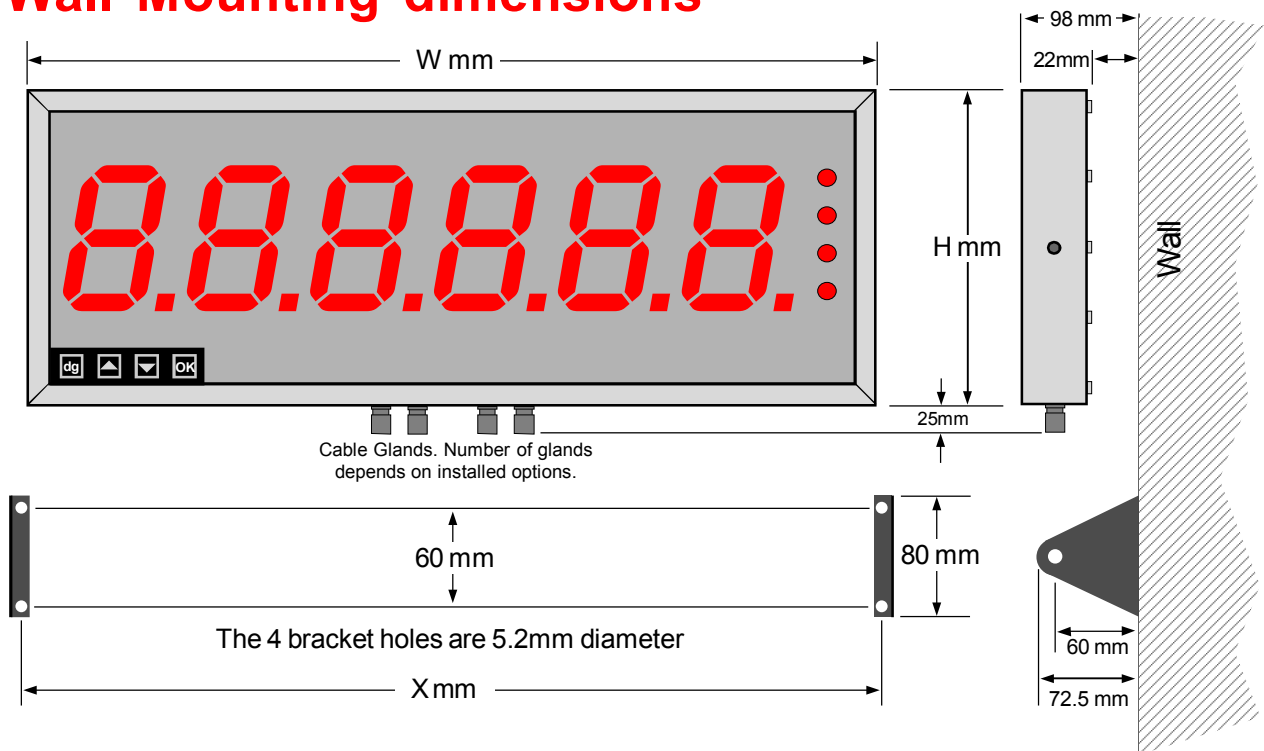

Detail showing bracket hardware fitting sequence

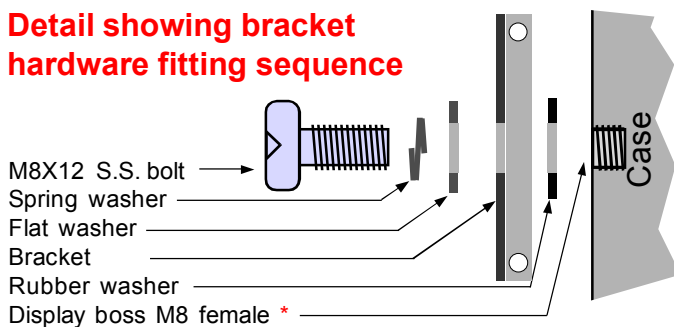

You can order these displays with the cable glands in the bottom surface (as shown) the rear, or top.

Rear glands allow you to mount the display on top of a cubicle, using the brackets shown.

*** Do not use longer bolt threads than 12mm , or you will fracture the female boss and the case will no longer be sealed.**

Display Format	X mm	H mm	W mm
2" 4 digit clock	278	154.5	291
2" 4 digit numeric	266.5	154.5	279.5
2" 6 digit clock	387	154.5	400
2" 6 digit numeric	363	154.5	376
4" 4 digit clock	440	195.5	453
4" 4 digit numeric	421	195.5	434
4" 6 digit clock	640	195.5	653
4" 6 digit numeric	603	195.5	616
6" 4 digit	567	246	580
6" 6 digit	807	246	820
8" 4 digit	737	290	750
8" 6 digit	1059	290	1072
12" 4 digit	1037	408	1050
12" 6 digit	1527	408	1540
16" 4 digit	1355	515	1368
16" 6 digit	2007	515	2020

Panel mounting dimensions

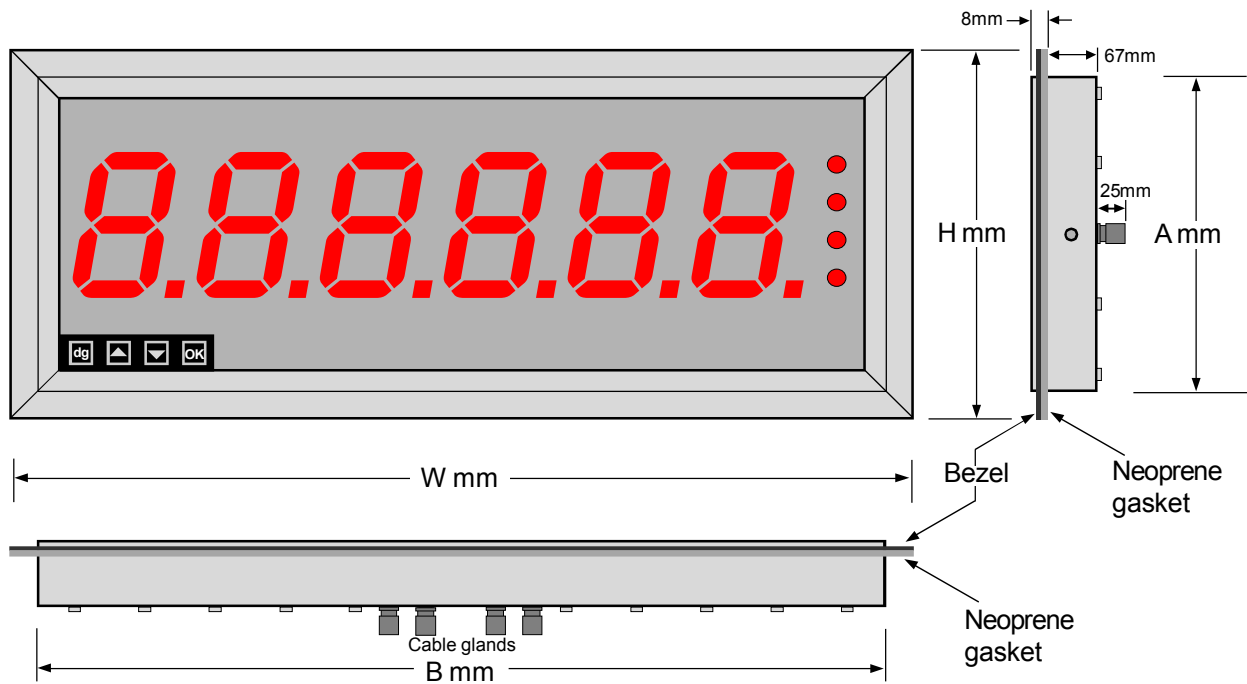

Detail showing bracket hardware fitting sequence

Panel cutout dimensions
 $A+3\text{mm}(h) \times B+3\text{mm}(w)$

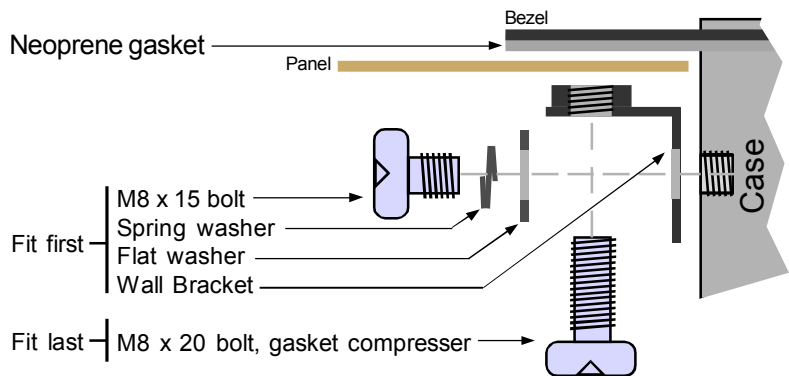

Display Format	H mm	A mm	B mm	Wmm
2" 4 digit clock	172.5	154.5	291	309
2" 4 digit numeric	172.5	154.5	279.5	297.5
2" 6 digit clock	172.5	154.5	400	418
2" 6 digit numeric	172.5	154.5	376	394
4" 4 digit clock	213.5	195.5	453	471
4" 4 digit numeric	213.5	195.5	434	452
4" 6 digit clock	213.5	195.5	653	671
4" 6 digit numeric	213.5	195.5	616	634
6" 4 digit	264	246	580	598
6" 6 digit	264	246	820	838
8" 4 digit	308	290	750	768
8" 6 digit	308	290	1072	1090
12" 4 digit	426	408	1050	1068
12" 6 digit	426	408	1540	1558
16" 4 digit	533	515	1368	1386
16" 6 digit	533	515	2020	2038

Connections



Warning:
Disconnect all power before removing the rear of the display

There is a wide range of possible locations for the input board, output board and power supply board/s. Their locations depend on the height of digits, number of digits, brightness of digits and any installed options. Because the permutation of possible locations is large, we will not describe the location of boards within the display, but simply identify the connectors and their functions on each board, below ...

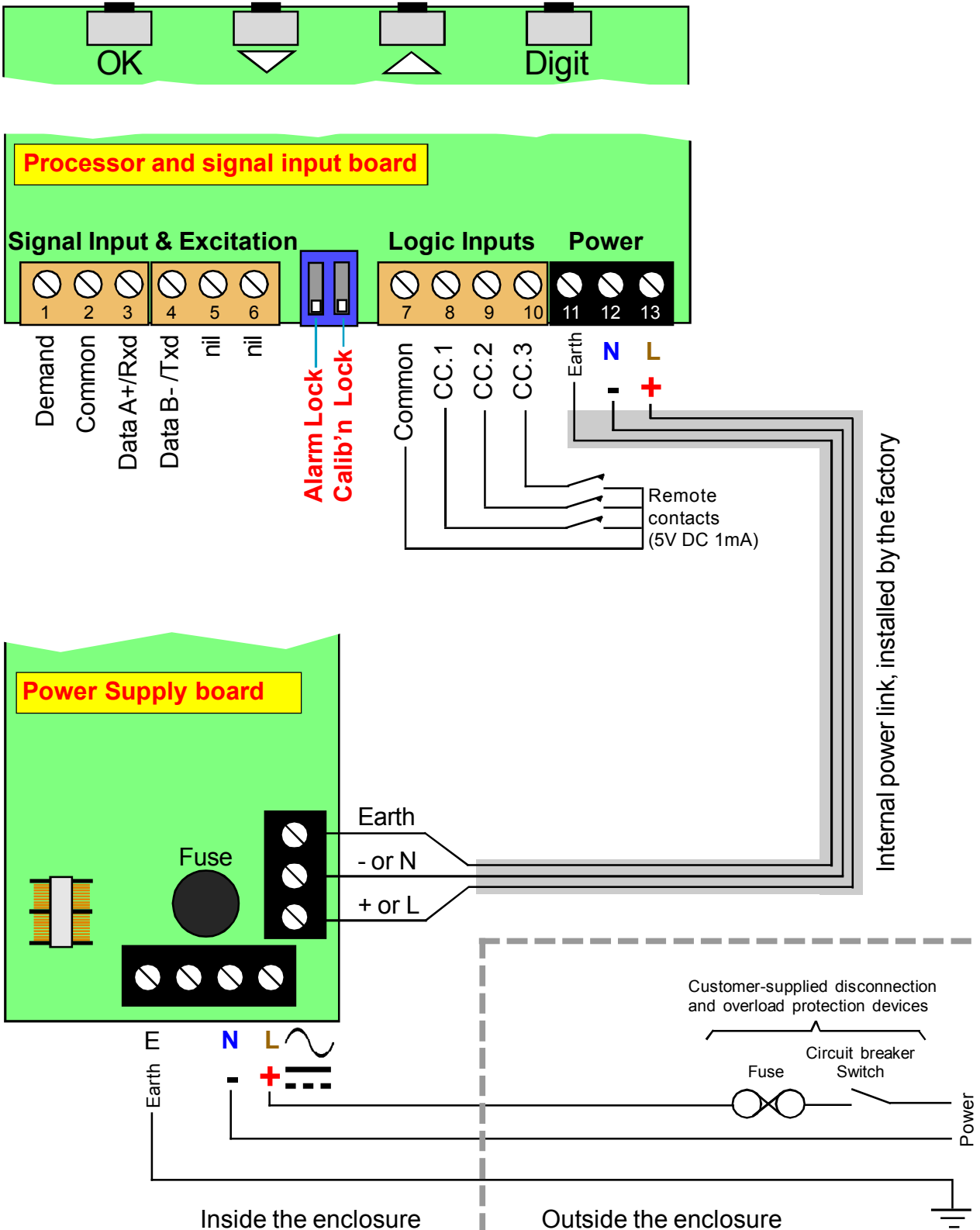

Connections

Warning:
Disconnect all power before removing the rear of the display

Connectors and options
Connectors may be present even if output options are not installed. Refer to rating label to see installed options.

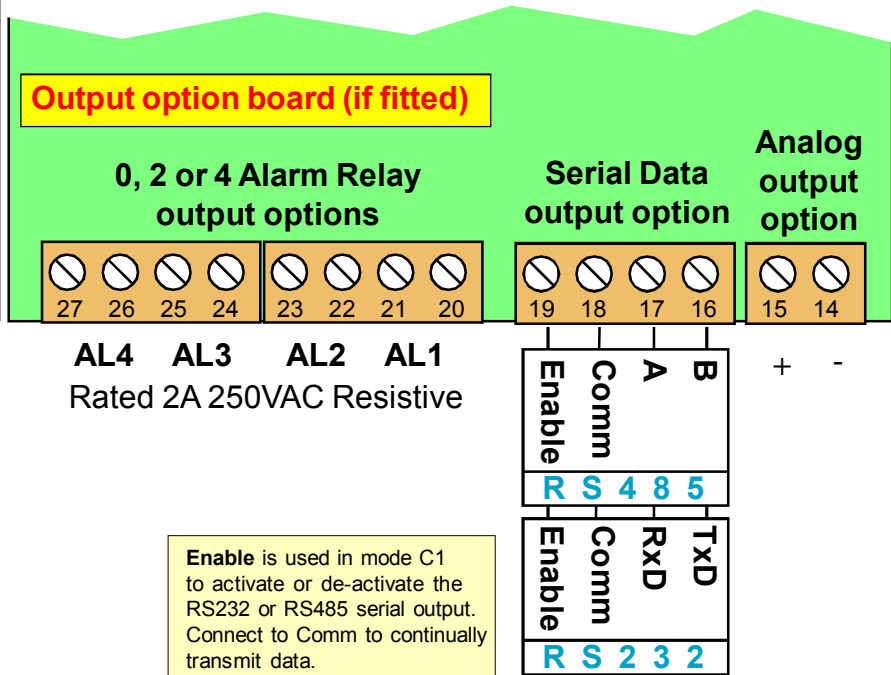

Remote programming button connector

On one of the display boards, you will find a 7 way connector, to which you can wire remote programming buttons, to allow adjustment of the display's settings when the display is inaccessible.

You can also enable or disable the display's front panel buttons, either by a remote contact closure, or by an on-board push-on jumper switch, which is located near to the remote button connector. When the contact is closed, or the push-on switch fitted, the front buttons are enabled.

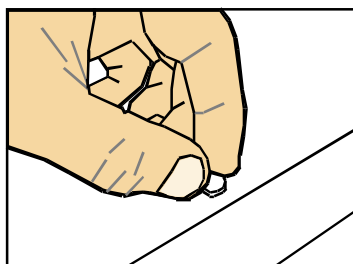
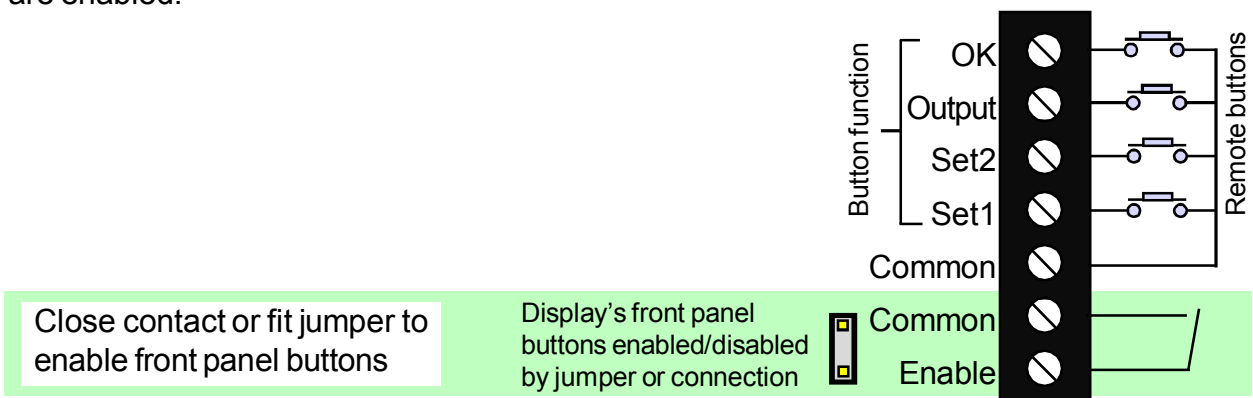

Rear case screws - please note

The rear panel is held in place with finger-screws, which only need to be gently tightened.

Do not use tools to tighten or loosen the screws, as this could cause damage to the internal threads.

Installation hints for best performance

This section offers several suggestions which will help you get the best performance from your system.

RS232 and RS485 use comparatively small signals which can easily be corrupted by the potentially high level of electrical noise which can be created by electrical machinery such as motors, welding systems, discharge lighting, AC power inverters and solenoids. These steps will ensure you get the best possible performance from your system.

RS232 has limited capability over long cable distances, due its low driving power (which causes the signal to reduce in level as cable length increases) and single ended signal (which is prone to interference by local electrical noise) , as shown below...

Maximum recommended cable distances if using LOW capacitance screened cable such as CAT5 cable.		
Baud Rate	RS232	RS485 or RS422
1200	50m	1200m
9600	20m	150m
19200	10m	75m
38400	5m	30m
115200	2m	10m

1. Use good quality screened signal cable, with twisted pairs. Screened twisted pair CAT5 cable is ideal. The screen should be earthed at the display end only.
2. If you are using multi-pair twisted cable, each pair should be dedicated to a single display as shown opposite, for maximum noise immunity. This will ensure that any electrical noise induced in the cable is properly cancelled. Mixing destinations carelessly amongst the twisted pairs can easily corrupt data.
3. The cable should be routed away from noisy wiring and devices such as power feeds from inverters, discharge-lighting cables, welder cabling etc, and should preferably be routed in a dedicated low voltage signalling/instrumentation conduit or cable tray.
4. If you want to simulate data, a useful free terminal, with good flexibility is RealTerm, available from <http://sourceforge.net/projects/realterm/>

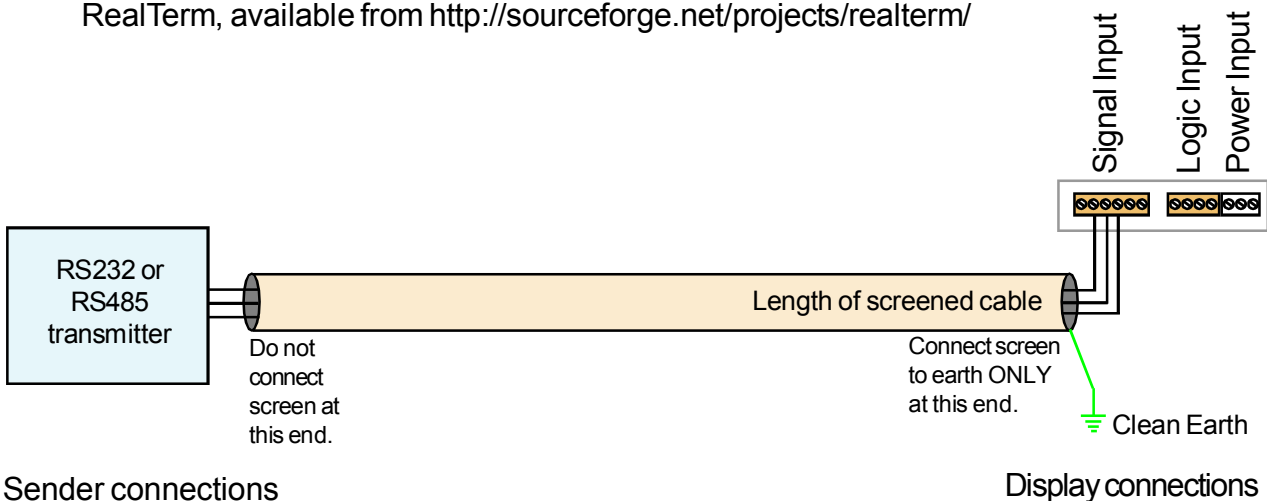

When using multi-core screened cable to connect several displays to several data sources, please be sure to use one twisted pair for each display and sensor.

Do NOT use a wire from one pair for signal positive and a wire from another pair for signal negative, as this will prevent the twisted cables from cancelling any induced electrical noise, and can couple noise from one source to another.

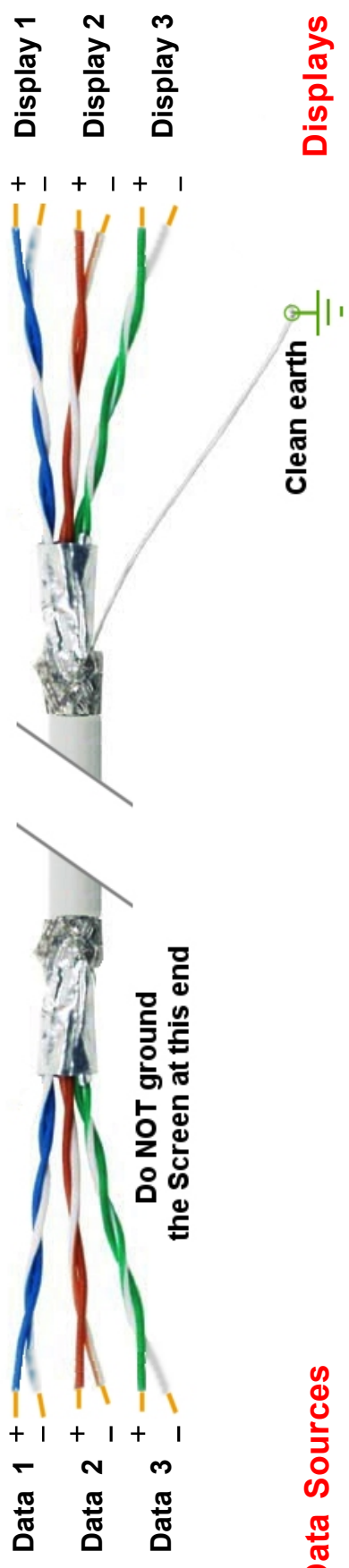

Declaration of CE Conformity

Declaration Reference : LD Mk2
Issue Date : 30 April 2007
Products Covered : LD Mk2 series
Title : DOC-INTUITIVE2

This is to confirm that the Product covered by this declaration has been designed and manufactured to meet the limits of the following EMC Standard :

EN61326-1:1997

and has been designed to meet the applicable sections of the following safety standards

EN61010-1:2001



Conditions

The meters are permitted a worst case error of 1% of A/D range during electro-magnetic disturbance, and must recover automatically when disturbance ceases without the need for human intervention, such as resetting, power-down etc.

The meters covered by this certificate must be installed in adherence to the following conditions :-

Signal cabling shall be routed separately to power carrying cabling (includes relay output wiring)

All signal cabling shall be screened. The screen shall only be terminated to the power earth terminal at the meter end of the cable.

Declared as true and correct, for and on behalf of London Electronics Ltd.

J.R.Lees Director

48V AC power wiring option

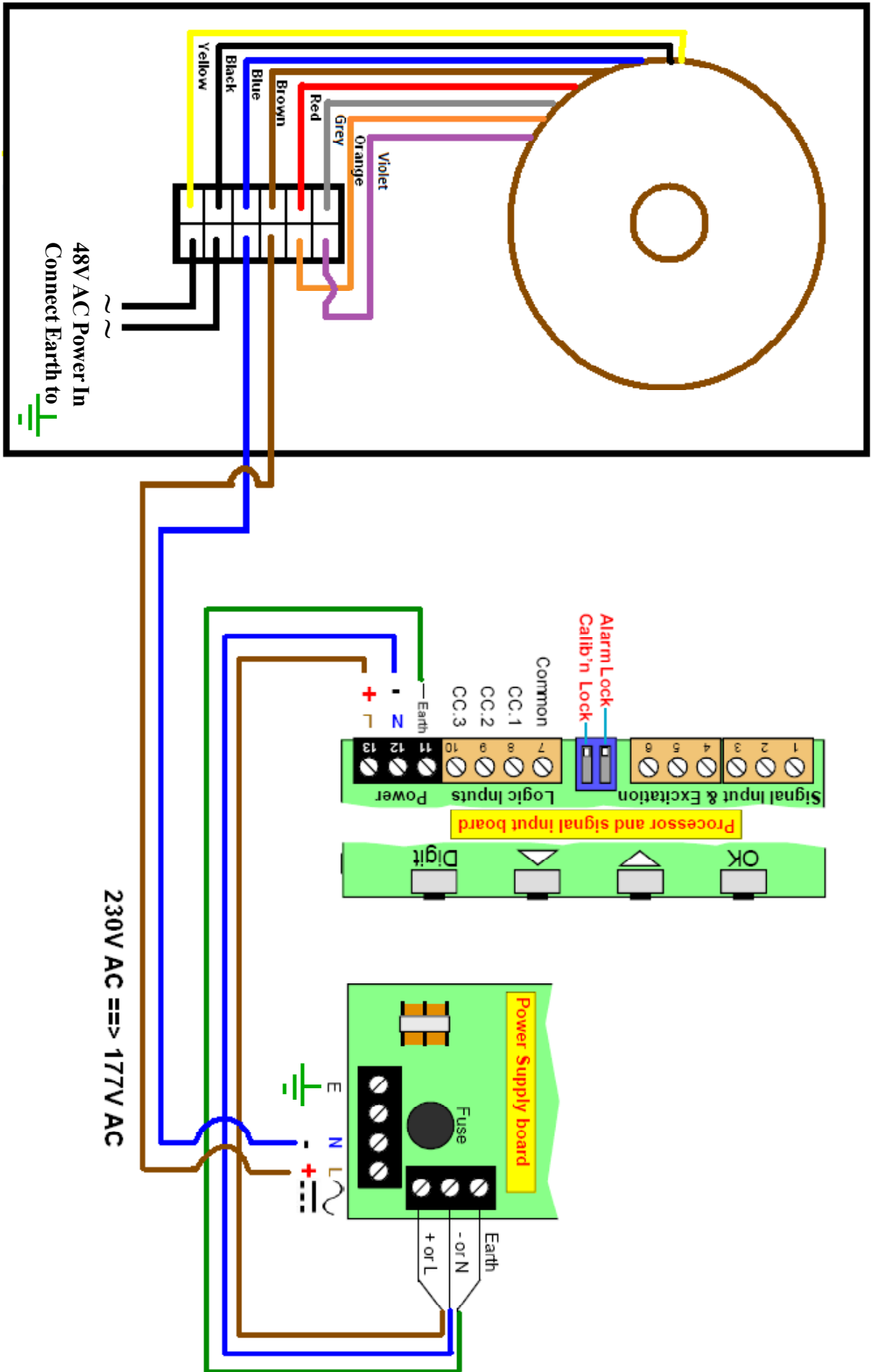

Display Brightness

You can adjust the display brightness at any time, provided the display is locked.

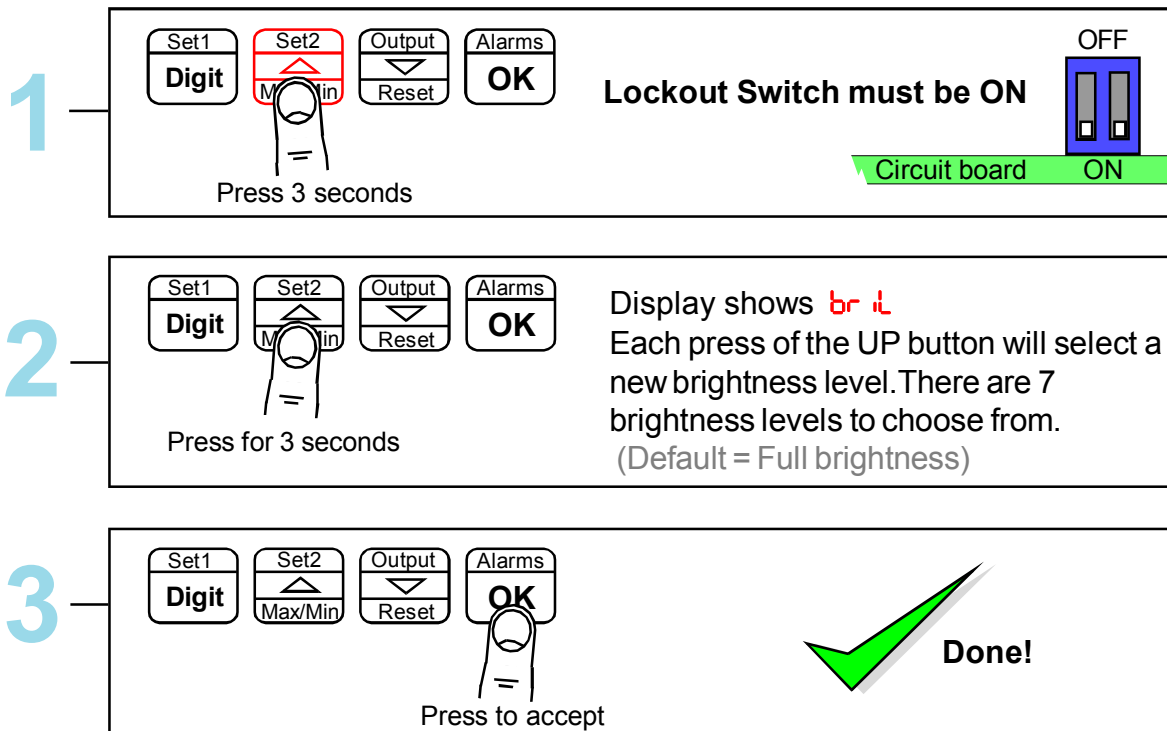

Did you know, we make this display in two brightness versions? Standard brightness for use inside, and Daylight Viewing for use outside in direct sunlight. The Daylight Viewing version has suffix -DLV in its part number.

Display Modes

You can choose from three operating modes.

1

Set1 **Digit** Set2 Max/Min Output Reset Alarms **OK** Lockout Switch must be OFF

Press 3 seconds

Circuit board ON

2

Set1 **Digit** Set2 Max/Min Output Reset Alarms **OK** Display shows **ASC**, **g.u.An** or **g.tot**

Press to select

ASC (ASCII) is used for any application where non-numeric characters may need to be displayed. You can not have alarms, analogue output, tare, peak, valley or any mathematical functions with this mode.

g.u.An is used for any numeric display work which needs alarms, analogue output, tare, peak, valley or mathematical funtions.

g.tot is used in applications where you want to sum values, for example to add together ingredient weights to get a combined weight.

3

Set1 **Digit** Set2 Max/Min Output Reset Alarms **OK**

Press to accept

Done!

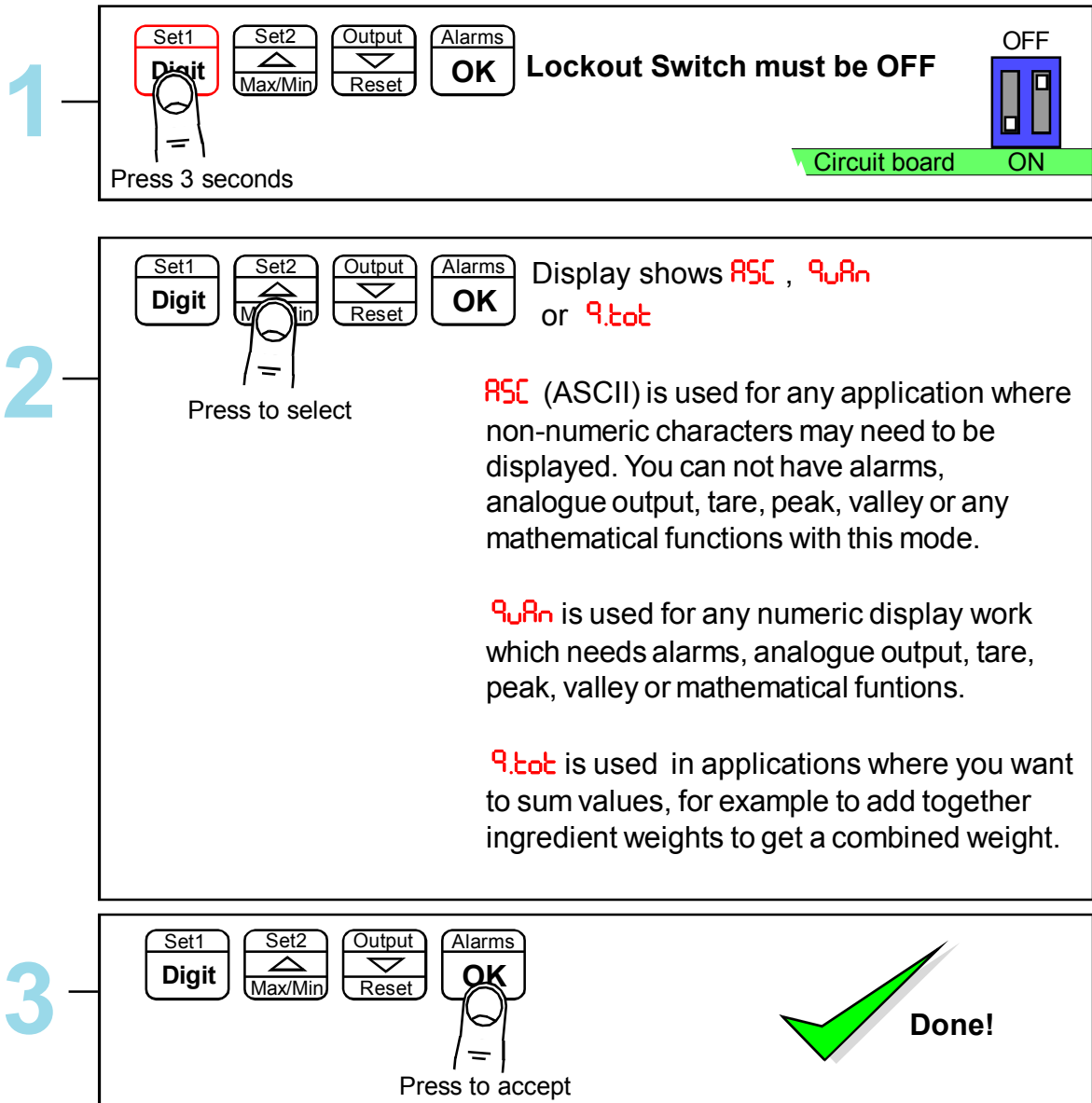

Serial Data settings

Choose the serial data settings to suit the transmitting device.

1

Press 3 seconds

Lockout Switch must be OFF

Circuit board ON

2

Display shows each of the parameters and you can edit or move on to the next one with the OK button.

You can edit the settings with the DIGIT, UP and DOWN buttons. OK to accept.

The default parameters are:-

Ad.01	The display's address, from 00 to FF. Choose 00 if you do not need addressing.
S.C.02	The Start Character. 02 = STX. Select 00 if you do not have a defined start character.
E.C.03	The End Character. 03 is ETX, 0d is Carriage return
bAud 9600	Choose a baud rate to suit the sender.
8n 1	Data format 8 data bits, no parity, 1 stop
t.r.05	Time to reply following a request, in mS
t.c.00	Time in mS between each character.
to. 03	Timeout Secs. if data lost. Display shows -----
S.P.00	Start position for data editing (see opposite)
d.L.06	Data length for editing (see opposite)
d.d.d.d.	Decimal point position for alarms

3

Press to accept

Done!

Serial Data setting examples

Sending data to an addressed display

Let us assume the display has address 45 and you want to send the value 123.4 to it at 19200 baud. Your data will be sent as <STX>45123.4<CR>

Set

```
Ad.45,  S.C.02,  E.C.0d,  bAud 19200,  8n1,
t.r.05,  t.c.00,  to. 03,  S.P.00,  d.L.06,
ddd.d
```

Extracting data from a complex string (data editing)

Let us assume the data is sent as a complex string at 1200 baud such as ... <Start Char><Address Characters><Data: ligo6ho987hmw1234.56kg abcd><End Char.> and you want to display only the numeric weight value...

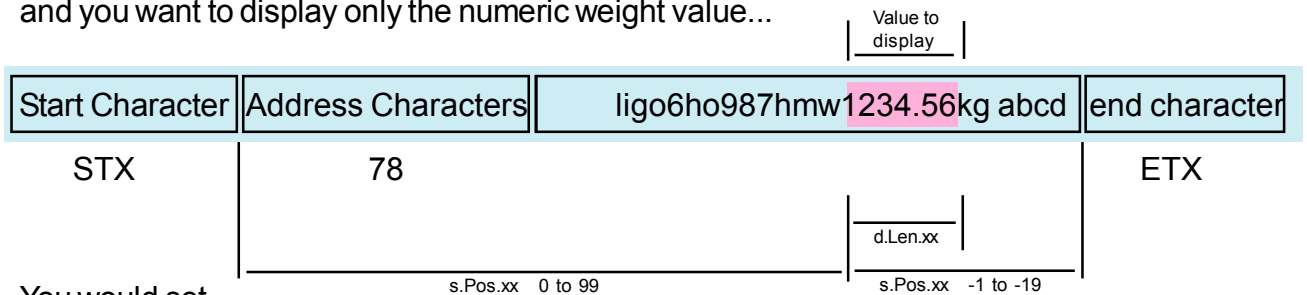

You would set....

```
Ad.78,  S.C.02,  E.C.03,  bAud 1200,  8n1,
t.r.05,  t.c.00,  to. 03,  S.P.15,  d.L.06,
dd.dd,
```

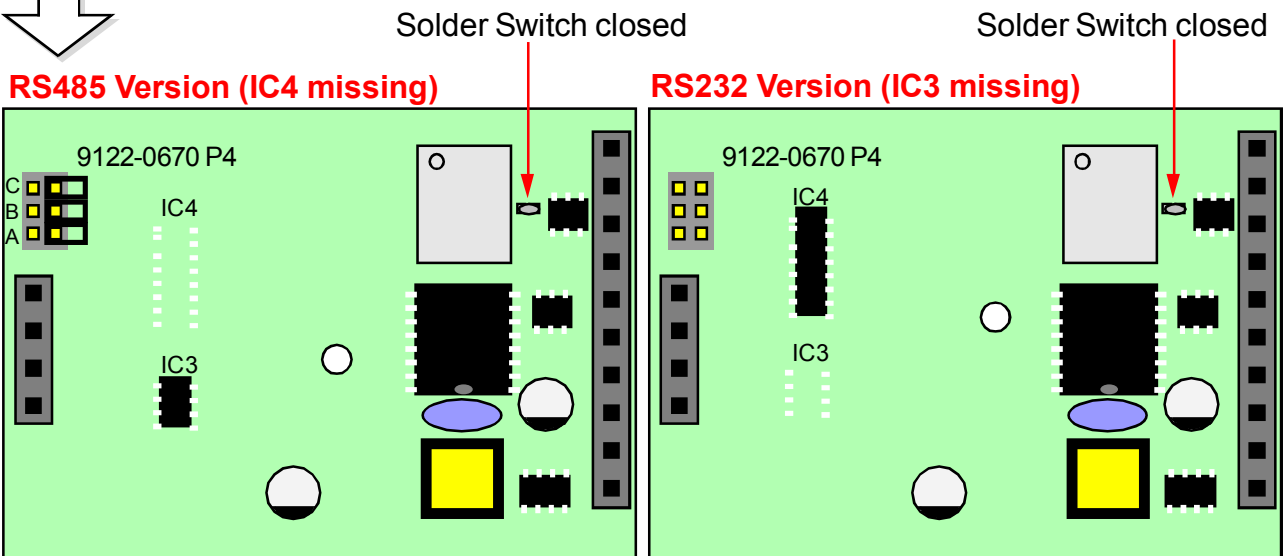
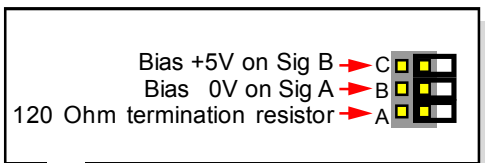

Logic input functions

The three contact closure inputs on the rear of the meter have default functions which are:-

- Contact closure 1 = Tare
- Contact closure 2 = Peak/Valley display
- Contact closure 3 = Reset

You can re-assign these to include :HOLD, Nett/Gross value display, Memory page address 1,2 or 4 (only if Multi-memory MEM option is installed)

1

Set1
Digit



Set2
▲
Max/Min

Output
▼
Reset

Alarms
OK

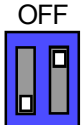
Lockout Switch must be OFF



Press 3 seconds

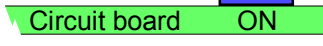

2

Set1
Digit

Set2
▲
Max/Min

Output
▼
Reset

Alarms
OK

Press repeatedly until you see **CC.1**, followed by the existing function for Contact Closure 1.

After you have set **CC.1**, you will get the prompt **CC.2** to allow you to set Contact Closure 2 function and when you have set CC.2 you will get the prompt **CC.3** to allow you to set Contact Closure 3 function



3

Set1
Digit

Set2
▲
Max/Min

Output
▼
Reset

Alarms
OK

Use UP or DOWN buttons to select from these available functions...

Defaults are:-

CC.1 = tArE	tArE = Tare display to 0
CC.2 = PU	PU = Peak/Valley toggle
CC.3 = rSt	rSt = Reset
	HoLd = Freeze display
	ne.Gr = Nett / Gross display
	PA.1 = Page Address 1*
	PA.2 = Page Address 2*
	PA.4 = Page Address 4*

4

Set1
Digit

Set2
▲
Max/Min

Output
▼
Reset

Alarms
OK

Done!





Press to accept

* Only available if the Multi-memory MEM option is installed

Logic input connections and front buttons

The previous page explained how to select the functions of the 3 logic inputs. You can connect remote contact closures or open NPN collectors to activate these logic inputs.

The logic input provides a 5V DC signal. When you connect this to common, a current of 1mA will flow. Because this is a small signal, we recommend you use switches with gold plated contacts, or self cleaning contacts, for best long term reliability.

The logic inputs are not galvanically isolated from the input signal.

The logic inputs are only activated when the lockout switch is ON

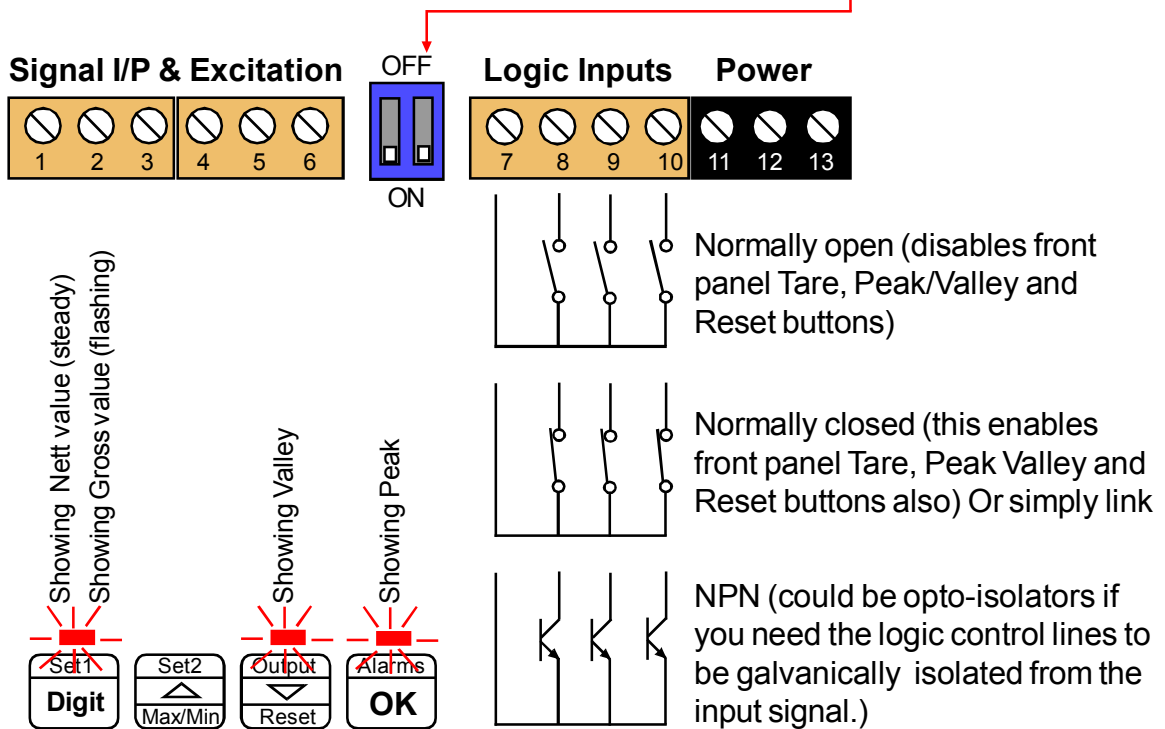

- tArE** = Tares display to 0. Often used in weighing systems to zero a display prior to making a measurement. Net weight is shown once tared. When a display has been tared the small LED above the Set1 button will be illuminated.
- PU** = Peak/Valley toggle. Allows you to view the maximum and minimum values which have been displayed since last reset. 0% LED illuminates when showing valley, 100% LED illuminates when showing peak.
- rSt** = Reset. This clears any tare, peak, valley, alarm latch
- Hold** = Freezes the displayed value for as long as the Hold input is closed
- nt.Gr** = Allows you to toggle between Nett and Gross values on the display
- PR. 1 .. 4** = Page Addresses, if MEM option is installed.

Factory Defaults

You can return the display to its factory default conditions whenever you wish. If you do so, you will permanently lose all your settings and will need to start from the beginning again.

The calibration Audit Counter will NOT be reset, there is no way provided to reset this value, as it is intended as a secure record to indicate whether changes have been made to the display since it was last calibrated..

1

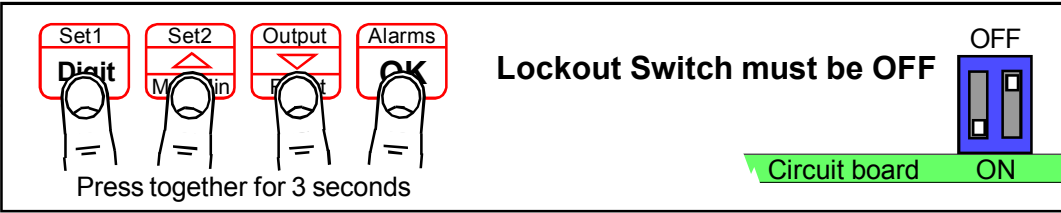

Press together for 3 seconds

Lockout Switch must be OFF

Circuit board ON

2

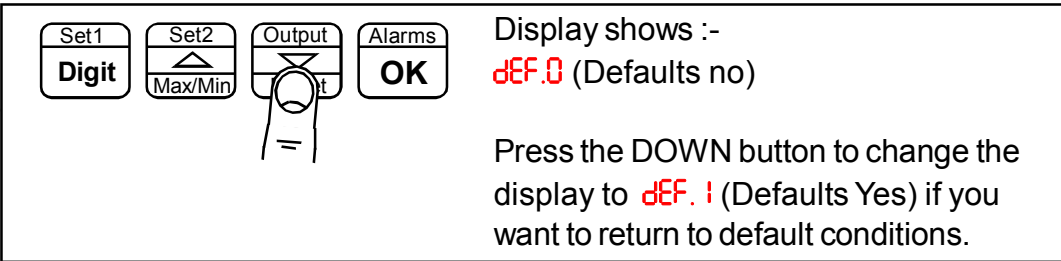

Display shows :-
dEF.0 (Defaults no)

Press the DOWN button to change the display to dEF.1 (Defaults Yes) if you want to return to default conditions.

3

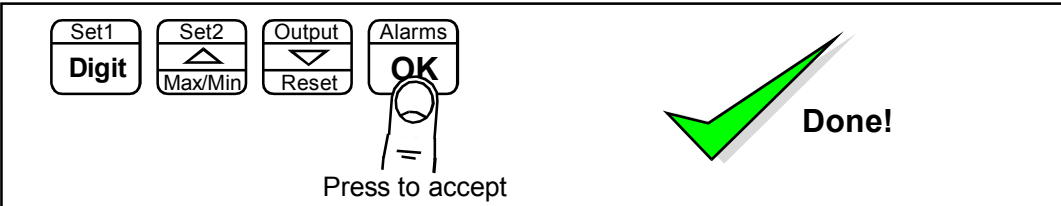

Press to accept

Done!

Calibration audit number

Your display includes a non-resettable counter which increments each time you make a change to the display's calibration. This is useful if you want to check whether a display has been altered since it was last calibrated.

The Calibration audit number starts at **CL01** up to **CLFF** allowing up to 255 alterations to be recorded. Whenever you want to check the calibration audit number, press and hold the 2 outer buttons (Set1 + Alarms) for more than 3 seconds.

1

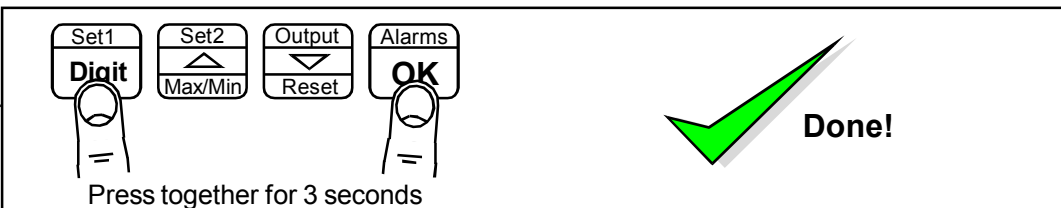

Press together for 3 seconds

Done!

Scale Factor adjustment

After you have calibrated your meter, you can use the SCALE feature to make fine adjustments to calibration, without affecting the calibration itself. You must have mode = **9.0An**

Examples

1. Changing weight units of measure from kg to pounds

You could also use the SCALE to convert your readout from kg to pounds, without affecting the calibration. Simply set SCALE = 2.205 and your meter which was calibrated in kg will now read in pounds.

2. Correcting for gravitational variance

Your weighing system was calibrated where gravitational acceleration = 9.812m/s^2 (London) You then move the system to Bangkok where gravitational acceleration is reduced to 9.782m/s^2

You can correct for this difference by setting Scale = $9.812 / 9.782 = 1.003$, so that a given mass in Bangkok will show the same weight as it did in London. Set Offset = 0.0000

See http://en.wikipedia.org/wiki/Earth%27s_gravity

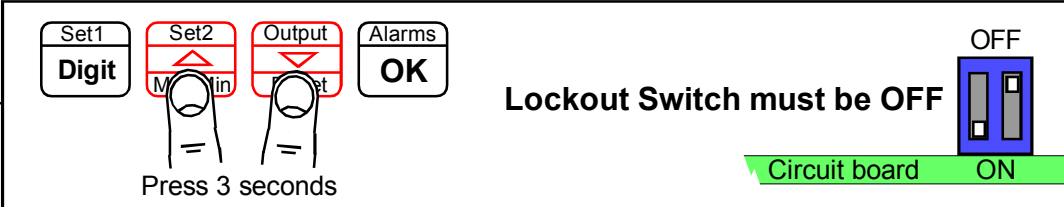
- 

1 — Lockout Switch must be OFF

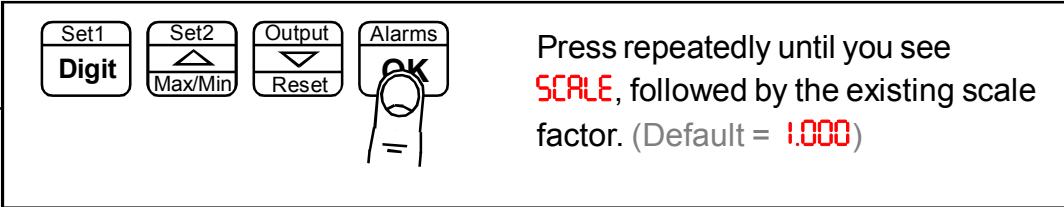
Press 3 seconds
- 

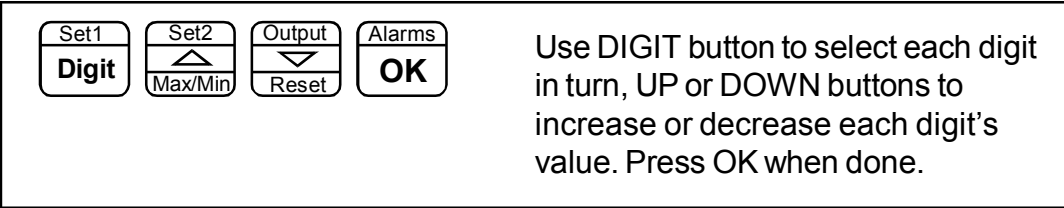
2 — Press repeatedly until you see **SCALE**, followed by the existing scale factor. (Default = 1.000)
- 

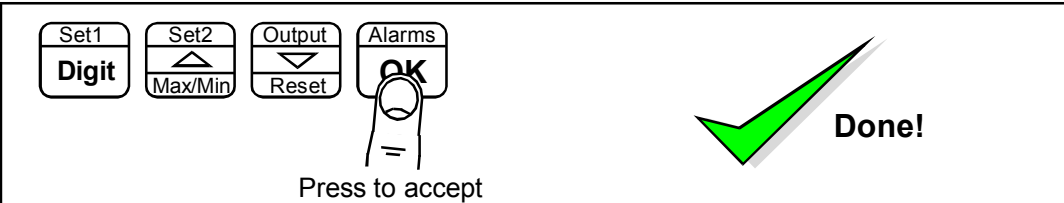
3 — Use DIGIT button to select each digit in turn, UP or DOWN buttons to increase or decrease each digit's value. Press OK when done.
- 

4 — Done!

Press to accept

You may want to adjust an offset value also, see separate OFFSET page for this feature.

Offset adjustment

After you have calibrated your meter, you can use the **OF.St** feature to make fine additions or subtractions to the reading, without affecting the calibration itself.

You must have mode = **QuAn**

For example if your weighing structure is altered after calibration and you want to subtract the effect of 37kg of extra metalwork which was welded to the hopper, you can easily do this by entering a value of -37 in the offset value.

1

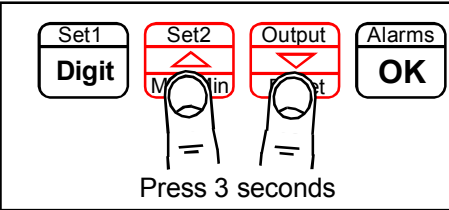

Set1 Digit Set2 Max/Min Output Reset Alarms OK

Press 3 seconds

Lockout Switch must be OFF



Circuit board ON

2

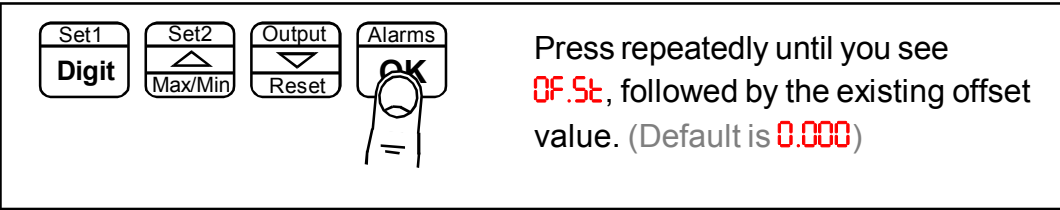

Set1 Digit Set2 Max/Min Output Reset Alarms OK

Press repeatedly until you see **OF.St**, followed by the existing offset value. (Default is **0.000**)

3

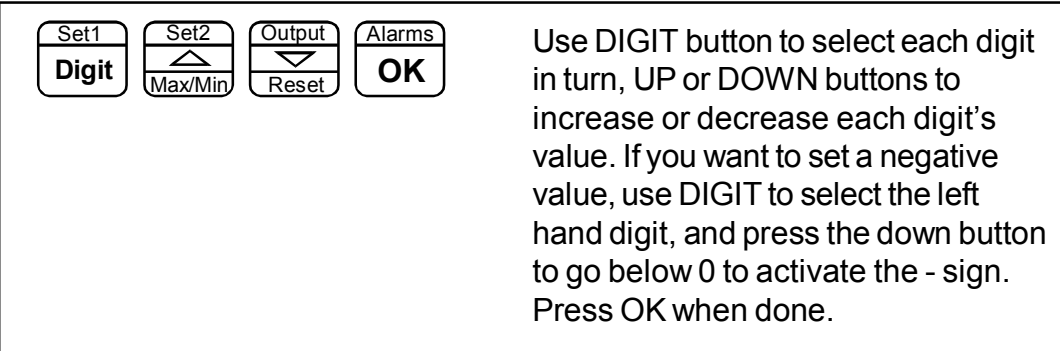

Set1 Digit Set2 Max/Min Output Reset Alarms OK

Use **DIGIT** button to select each digit in turn, **UP** or **DOWN** buttons to increase or decrease each digit's value. If you want to set a negative value, use **DIGIT** to select the left hand digit, and press the down button to go below 0 to activate the - sign. Press **OK** when done.

4

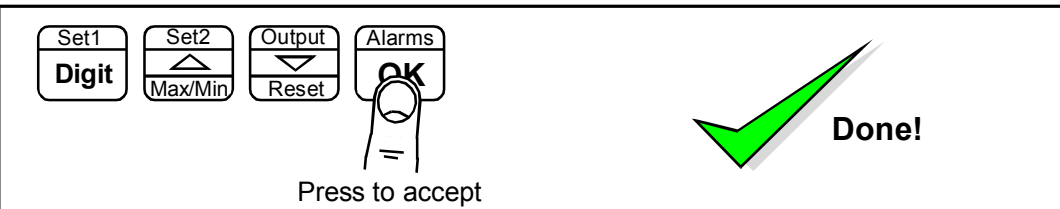

Set1 Digit Set2 Max/Min Output Reset Alarms OK

Press to accept

Done!

You may want to adjust a **SCALE FACTOR** value also, without affecting calibration. See the separate **SCALE** page for this feature.

Menu timeout adjustment

The display has a default timeout of 60 seconds, to allow you sufficient time to refer to the manual between key operations.

You can make this period shorter, if you wish, once you become more familiar with the setup method.

1

Set1 Digit Set2 Max/Min Output Alarms

Lockout Switch must be OFF

Circuit board ON

Press together, briefly

2

Set1 Digit Set2 Max/Min Output Alarms

Reset OK

Press repeatedly until you see **⌘. XX** where **XX** is the delay in seconds. Choices are ...

⌘. 10
⌘. 20
⌘. 30
⌘. 60 (default)

3

Set1 Digit Set2 Max/Min Output Alarms

Reset OK

Press DOWN or UP button briefly and repeatedly to choose from **⌘. 10** or **⌘. 20** or **⌘. 30** or **⌘. 60**

Press briefly to toggle

4

Set1 Digit Set2 Max/Min Output Alarms

Reset OK

Press to accept

Done!

Reverse Display function (mirror image)

If you need to be able to see a reflection of the display in a mirror or other reflective surface, for example in a simple heads-up system, or for drivers reversing into a bay, using mirrors only, you can set the display to show as a mirror image.

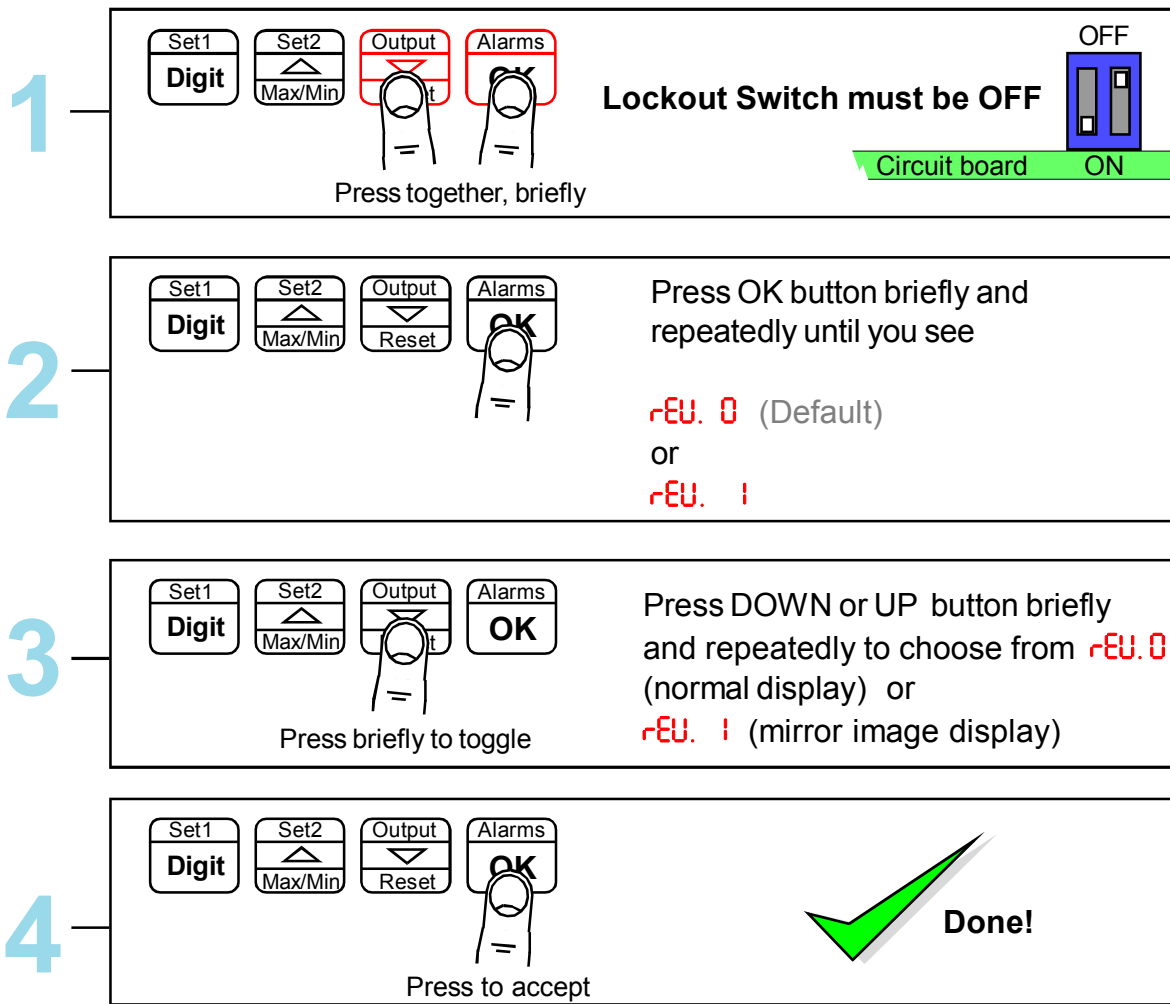

Example of normal display format displaying the number 876543



Example of Mirror Reverse display format displaying the number 876543

Bootup routine choices

When you switch on your meter, it can be set to power up with 3 possible summary message combinations.

The choices are:-

- bt 0** = Segment test, followed by a full summary of software revision, calibration audit number, model number, installed options.
- bt 1** = Segment test followed by model number (Default)
- bt 2** = No summary, meter displays the measurement value immediately power is applied.
- bt 3** = Segment test which remains active until a button is pressed

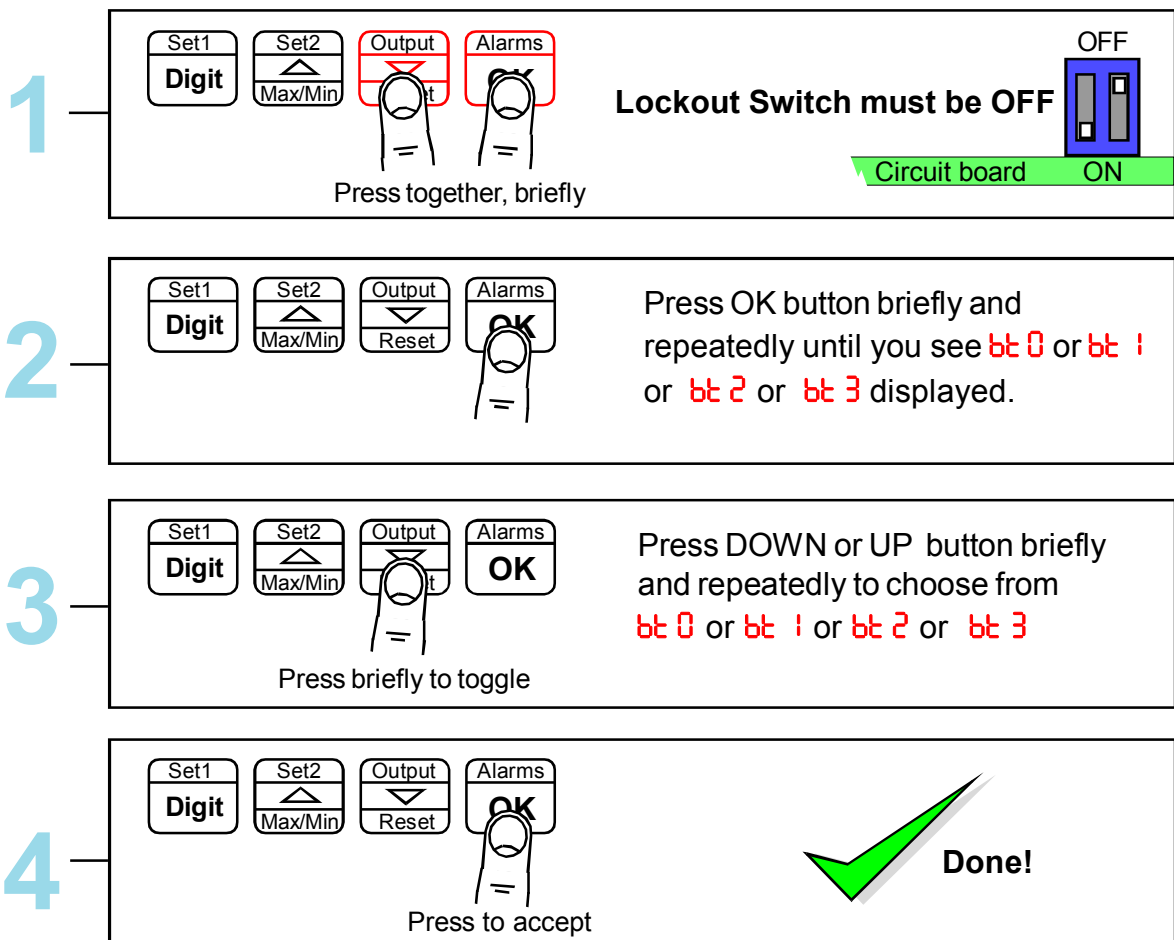

You can trigger the full summary message whenever you want, without having to power the meter off, by pressing and holding the 2 outer buttons (Set1 + Alarms) for more than 3 seconds.

Multi-Program Memory option MEM

The three contact closure inputs on the rear of the meter may be used to call up between 1 to 7 additional meter setup memories (pages), if the MEM option has been installed. This allows you to save up to 8 complete sets of independent calibrations, alarm settings, analogue output settings and serial comms settings.

First decide how many memory pages you want, as this will determine how many logic inputs you will need to use for the addressing. Logic inputs not required for Page Addressing can be used for other functions such as Tare, Reset, Display Hold, Peak/Valley display.

If you have used all 3 logic inputs for Page Addressing, you can still use the meter's front panel buttons to perform Tare, Reset and peak/Valley view.

See "Contact Closure Input Functions" page for CC.1, CC.2, CC.3 and COP settings

Total number of pages	Logic Inputs required for addressing
1	none, standard single page meter
2	1 Set CC.1 = PA.1
3 or 4	2 Set CC.1 = PA.1, Set CC.2 = PA.2
5 to 8	3 Set CC.1 = PA.1, Set CC.2 = PA.2, Set CC.3 = PA.4

1. Set lockout switches OFF, and set page address to 0 or unplug the logic connector.
2. Set the copy instruction to **COP. 1** in page address 0 (found after you set CC3) .
3. Press all 4 buttons together, display shows **dEF. n**
4. Press the Up arrow to change display to **dEF. y** and press OK.
5. If you want all channels to share a common setting, eg calibration, do that setting now.
6. When you want to do separate settings for each channel, set COP.0

Programming and recalling individual pages

Plug the logic input connector back in, if you removed it earlier. Select a page address using the switch combinations shown below, wired to the Logic Input connector ...

Page address 0	All logic inputs open
Page address 1	CC.1 closed to Common
Page address 2	CC.2 closed to Common
Page address 3	CC.1 and CC.2 closed to Common
Page address 4	CC.4 closed to Common
Page address 5	CC.1 and CC.3 closed to Common
Page address 6	CC.2 and CC.3 closed to Common
Page address 7	All logic inputs closed to Common

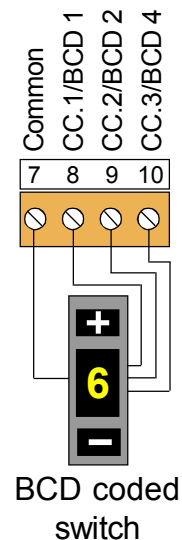

Perform the settings you require, according to the pages in this manual. Do this for all page addresses required. Then put the lockout switch in its ON position. Now, if you select a page address, the meter will briefly confirm the chosen page address on screen, and will then function according to the settings you programmed for that address.

Suitable BCD coded switches are available from many electrical supply stores. For example consider Kraus & Naimer part A540-600 E24 or Apem part number IRBC10N1248 or London Electronics part number SW2P-8W-BCD, which also provides separate 2 pole 8 way signal selection function.

Error codes and fault finding



1. Display shows minus signs.

This tells us that there is no response to input data, either because....

- a) There is no data, and the display has timed out
- b) There is an error in the data wiring.
- c) One or more of the menu settings may be wrong.

You can test for a) and b) with a simple data monitor which you can make with 2 diodes and a resistor, as shown below.

The Green LED should be on for most of the time, and you should see the red LED flicker as data is sent.

If the red LED is lit most of the time, with the green flickering, your wiring may be transposed.

If neither LED is lit, check your data source to make sure it is configured to transmit continuously, and check your connections to make sure the cabling and connector terminals used are correct.

If the Green LED is on, but no flickering of the red is seen, check that the data source has been set to transmit permanently. If the data source is another London Electronics Display, make sure it has been set to mode C1 and that the enable terminal on the serial output connector is connected to data common.

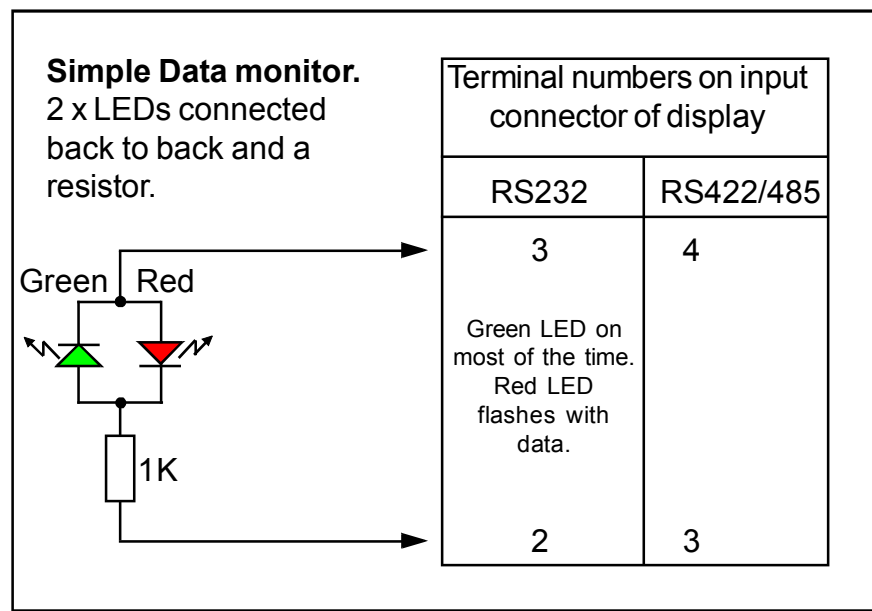

2. You can use your PC to generate and monitor serial data, with a free program called RealTerm which you can download from :-
<http://sourceforge.net/projects/realterm/>

This can be very useful in diagnosing communication problems.

How to install option boards



Where the product is intended for "UL" installations removal or addition of option boards is not permitted.



Warning: Disconnect power before you expose the internals of the display

If you want to open your display to install or modify option boards, follow these steps...

- 1) Switch off power to the display and unplug all connectors.
- 2) Undo all the thumb screws on the rear case, store them safely and remove the back panel
- 3) Locate the main option board, which will be similar in appearance to the diagram below. If a main option board is absent, which will be the case if the display was ordered without any output options, then a main option board will need to be fitted.

The board assemblies will look like this...

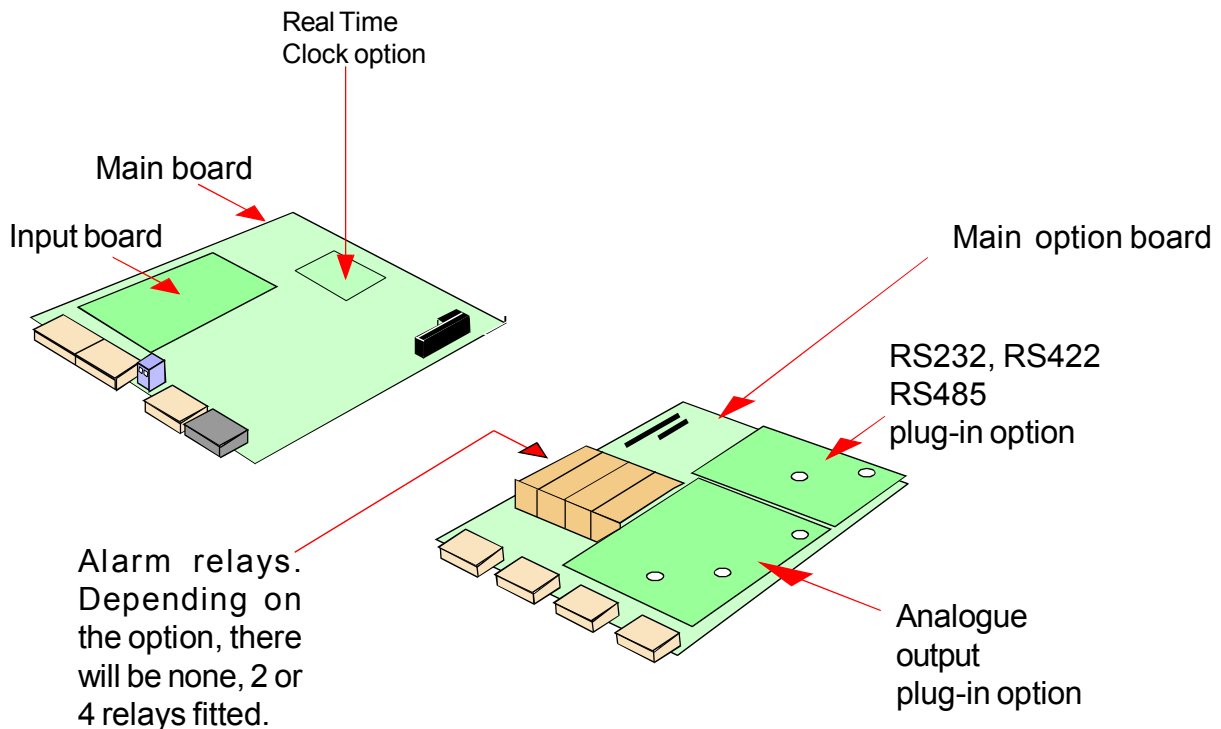

The analogue output and RS232 or RS422 plug-in option boards are fixed to the main option board with white plastic pillars. You must apply a firm force when fitting or removing these options.

Always be careful to connect the pins to sockets accurately. When reassembling, make sure option boards are firmly fixed to the upper option board.

Waste Electrical Electronic Equipment (WEEE)

In Europe, this equipment must be disposed of in accordance with European Parliamentary Directive 2002/96/EC

This directive encourages recycling and the reduction of waste materials in the environment.

This means it must be sent to an approved recycling plant if you want to dispose of it.

It must not be thrown away with general rubbish.



WEEE Waste Recycling

If you are unable to dispose of this item locally, you may send it to us for recycling.

Conditions:

1. We will only accept items of our manufacture.
2. You must pay for the transport of the goods to us.
3. We will only accept items if they include a signed declaration by an authorised person in your organisation, stating that :-
 - i. The item is safe to handle and has no contaminants which may be harmful to health.
 - ii. You wish us to dispose of or destroy the item(s)

Equipment Specifications

Case Material	Heavy duty welded uPVC
Connectors	Internal detachable Screw Terminal connectors accessed via compression glands.
Environmental	Storage Temperature range -20 to +70C, non condensing Operating temperature range 0 to 50C. Internal heater option available for use in conditions down to -25C. Please allow 30 minutes for the display to reach thermal equilibrium.
Power Burden	100-240 VAC, 45 to 60Hz, 48V AC or 11-30 VDC optional 40VA maximum
Sealing	IP65 all round, provided the display is mounted vertically and that all cable glands and rear case-closure screws are properly secured.
Input Signals	RS232 on model INT2-S2 RS422 and RS485 on model INT2-S4 Baud rate selectable from 300 to 115200 Data format selectable 701,7e1,7n2,80,8E,8n,8n2 Address 00 to FF Inter message delay time 00 to 99 mS Inter character delay time 00 to 99 mS
Display update rate	10 readings per second
Display range	-1999 to 9999
Plug-In Output Options	
Analogue O/P	See analogue output manual for details.
Alarm Relay O/P	See alarm output manual for details.
ASCII Data O/P	See serial output manual for details.
Calendar/Clock option	See serial output manual for details.

Record of Revisions

6 September 2010	Version F0.18 Software released. Manual format revised to improve clarity and segregate easy from advanced menu functions. Optional outputs now described in their own dedicated manuals. DIN Rail mounting option added. Cabling guidance added.
14 February 2011	Version F00.21 software released.
28 February 2011	Warranty increased to 3 years and terms added.
30 August 2011	Corrected Remote Programmer connection details.
8 August 2014	Version F00.23 software released.
21 January 2016	Mounting dimensions amended for flush case bosses

ASCII Hex codes and displayed characters

20 space	37 7	48 H	52 r	62 b	6c L	76 u
2D -	38 8	49 I	53 S	63 c	6d n	77 8
2E .	39 9	4a J	54 t	64 d	6e n	78 r
30 0	41 A	4b T	55 U	65 E	6f o	79 y
31 1	42 B	4c L	56 U	66 F	70 P	7a 2
32 2	43 C	4d n	57 8	67 9	71 9	
33 3	44 O	4e n	58 r	68 h	72 r	
34 4	45 E	4f O	59 y	69 ,	73 S	
35 5	46 F	50 P	5a 2	6a J	74 t	
36 6	47 6	51 9	61 A	6b T	75 u	

Other ASCII Hex codes and their characters are:-

Hex	Function	Hex	Function
02	STX	2c	,
03	ETX	2d	-
04	EOT	2e	.
0a	Line Feed	2f	/
0c	Form Feed	3c	<
0d	Carriage Return	3e	>
1b	Escape	5c	\
20	Space	5e	^
21	!	5f	_
25	%	60	'
26	&	7b	{
28	(7c	
29)	7d	}
2a	*	7e	~
2b	+	7f	DEL

Signal levels

These examples show a single ASCII character 2C (0010 1100) which is a Comma, so that you can see the voltages in RS485 and RS232 systems.

Typical UART output

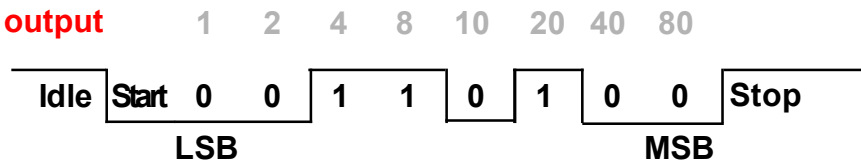

RS485 data line levels 8n1

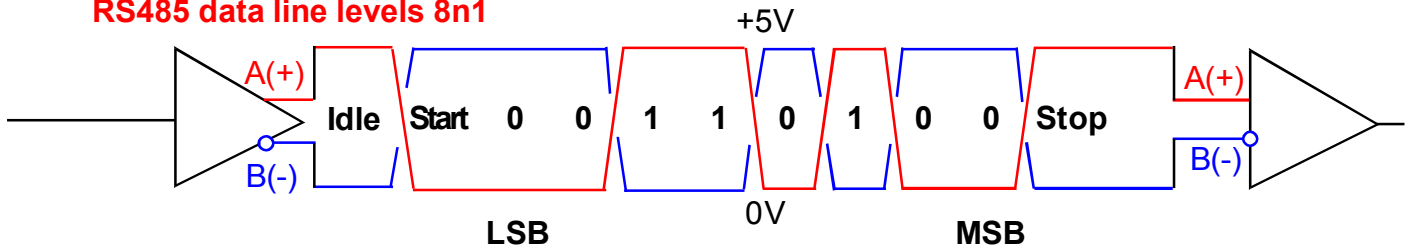

RS232 data line levels 8n1

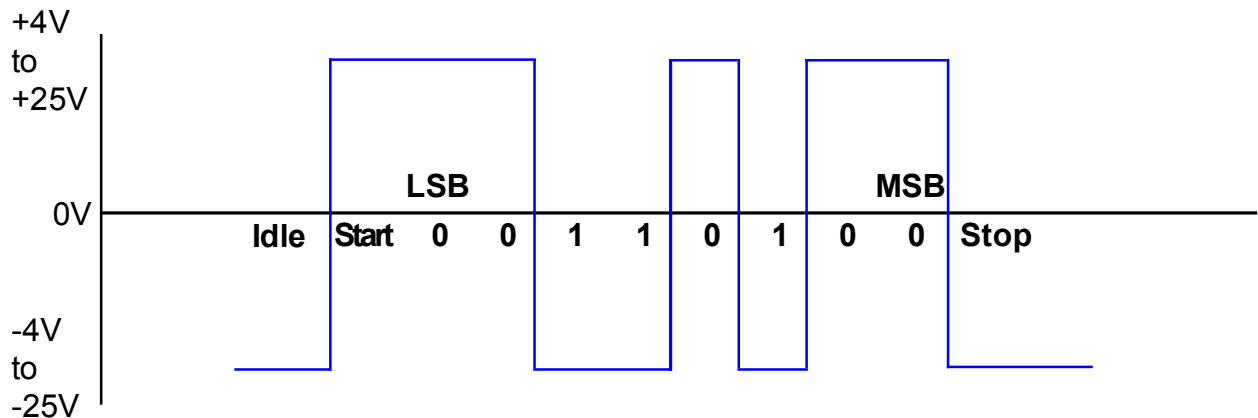

Special data commands

These messages are not handled by the normal data parsing. If the escape character '~' is the first available character the whole message is treated as a command message.

Message format is: <S.Chr><Addr>~[Command]<E.Chr>.

Display Brightness Control '~Bx' where 'x' is 1(dim) to 8(bright)
The brightness setting is not saved to non-volatile memory

Clear display '~C' Clears display and indicators (meter looks like it's turned off)
The display will return to its illuminated state on the next receipt of normal data.

Set/Clear Alarm Indicator '~Aas' where 'a' is the Indicator ID (0 to 3)
where 's' is the state (0 or 1)
When this command is received normal alarm indication is suspended until the meter is rebooted